







# Installation for Instruction



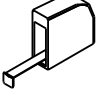

ITEM NO:LY9501-11

## Tools you need

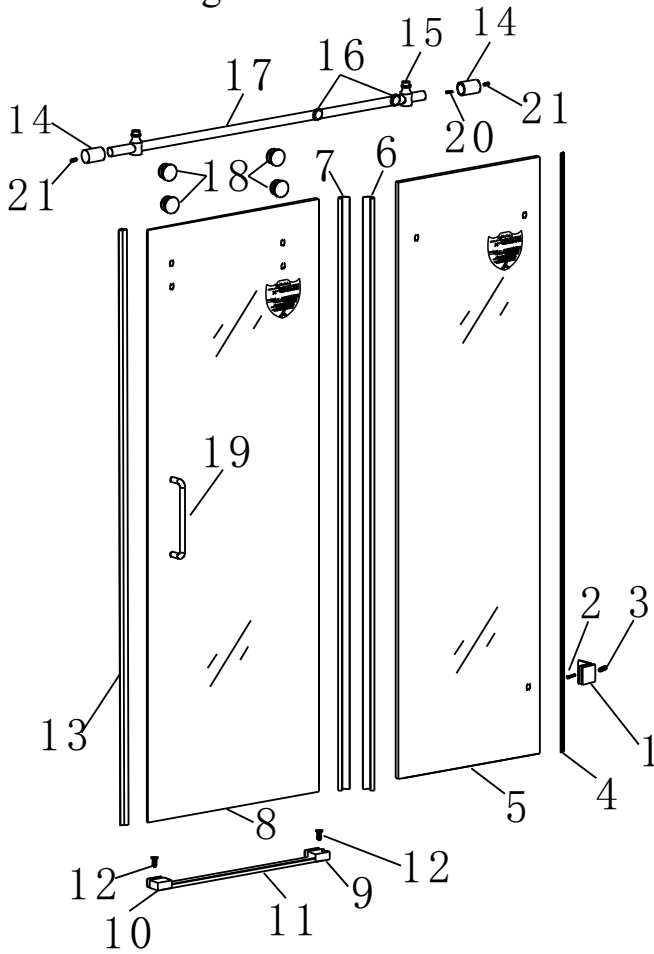
				
cross-screwdriver	hammer	electric drill	tape measure	caulking gun
				
Utility knife	horizontal ruler	pencil		

## Installation diagram

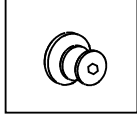
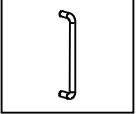
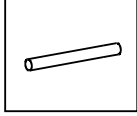
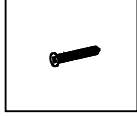
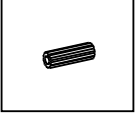

		
eccentric wheel	fixing clamp	tube
		
locator	pipe clamp	s/s handle
		
steel tube	Screw	Expansion glue

## Spare parts List

7	Water bar	14	tube	21	Inflatable glue 8mm
6	Water bar	13	bubble rubber bar	20	Tapping screw M6×50
5	fixing glass	12	Flat tapping screw M4×25	19	s/s handle
4	bubble rubber	11	Waterproof bar	18	eccentric wheel
3	Inflatable glue 8mm	10	Right sliding cover	17	steel tube
2	Tapping screw M5×35	9	Left sliding cover	16	pipe clamp
1	fixing clamp 45×45mm	8	movable glass	15	locator
No.	Description	No.	Description	No.	Description

①

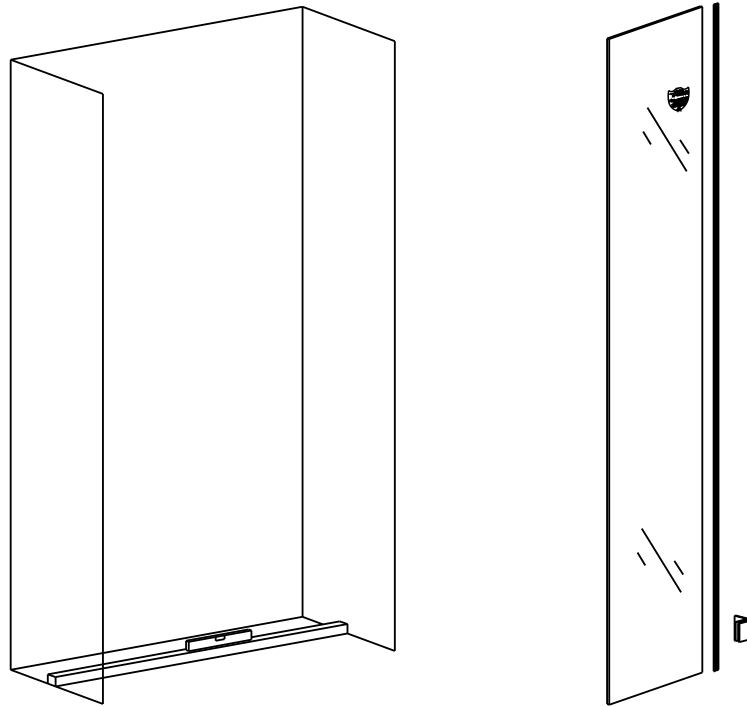

1. Select the installation position, put the base stone or tray to the position and measure it vertically by spirit level.
2. Assemble the accessories and glass, bubble rubber bar and fixing clamp on the fixing glass.

②

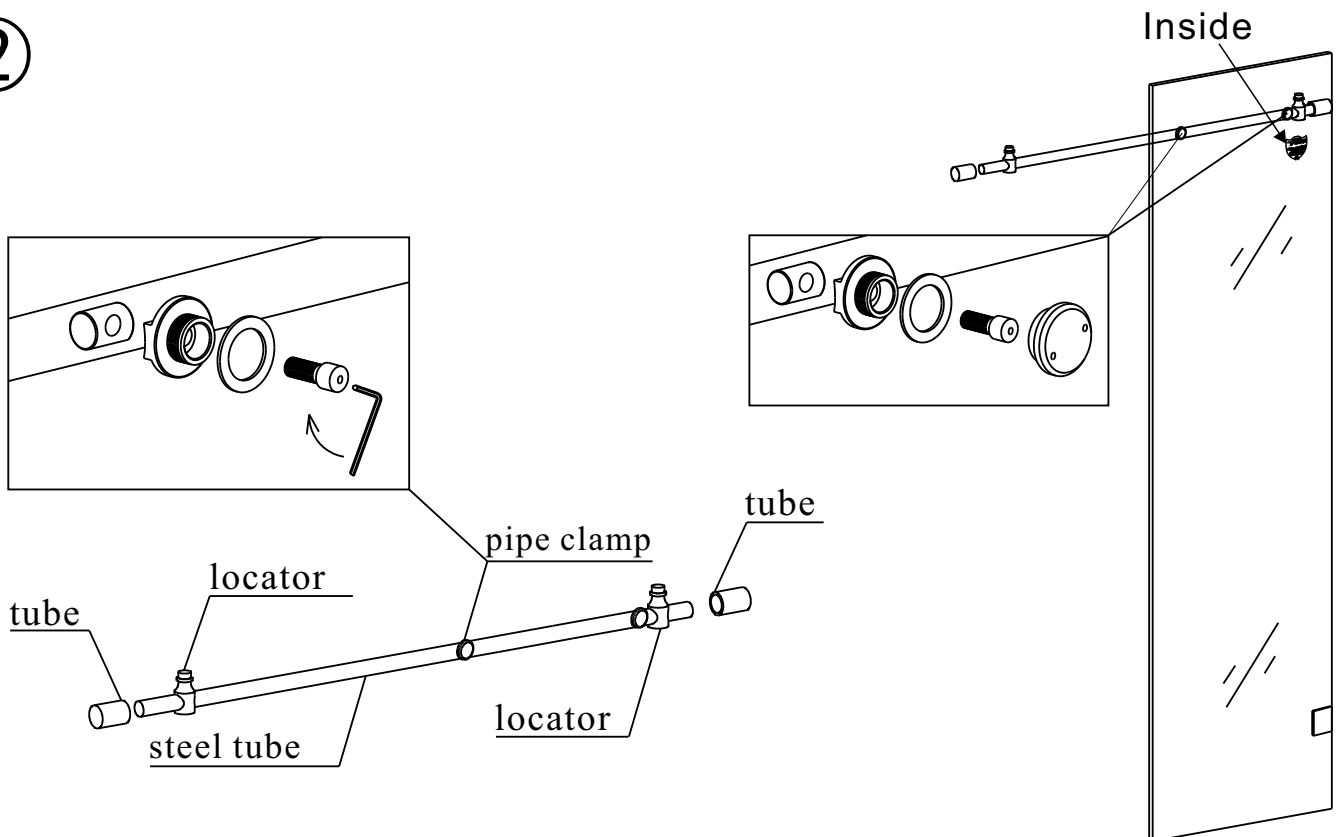

1. Install the rubber rail.
  2. Put the movable glass onto the sliding wheel, and install the upper rail.
- Attention: The safety membrane is stuck at the inside of the glass.

③

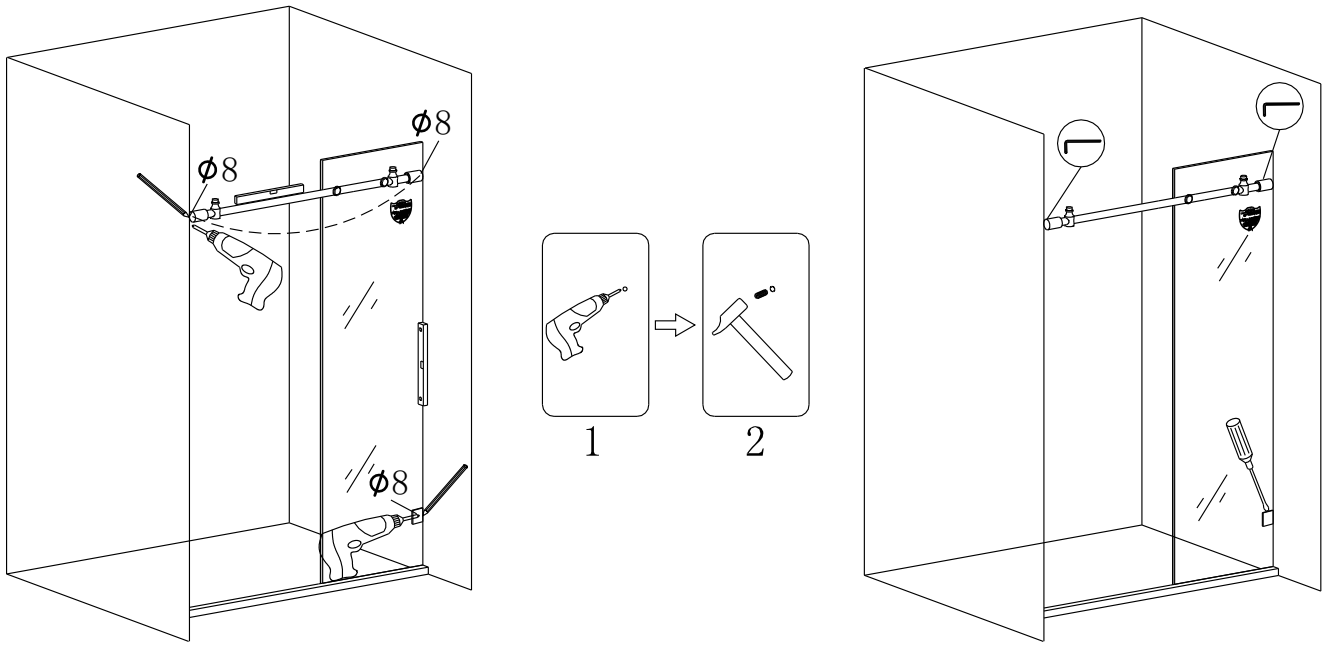

1. Put the fixing glass on the base stone, measure and make the upper rail and fixing glass vertically by spirit level, marked by pencil, then take off the fixing glass.
2. drill a hole by a driller on the marked position, and insert with inflatable rubber.
3. Put the fixing glass which is with rupper rail on the base stone, make it vertically. Locked the fixing clamp tight with tapping screw M5×35, and the tube is locked by flat tapping screw M6×50.

④

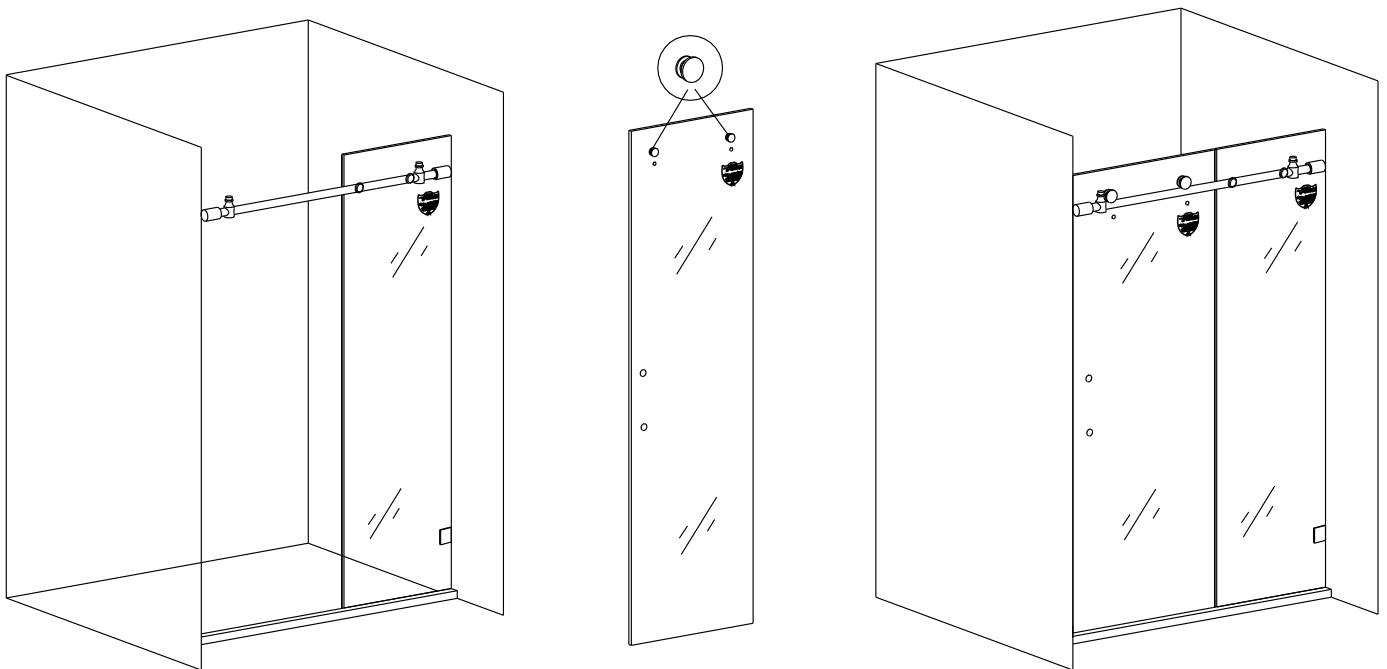

1. Put the fixing glass onto the waterproof bar.
2. Put the movable glass onto the sliding wheel, and install the upper rail.

5

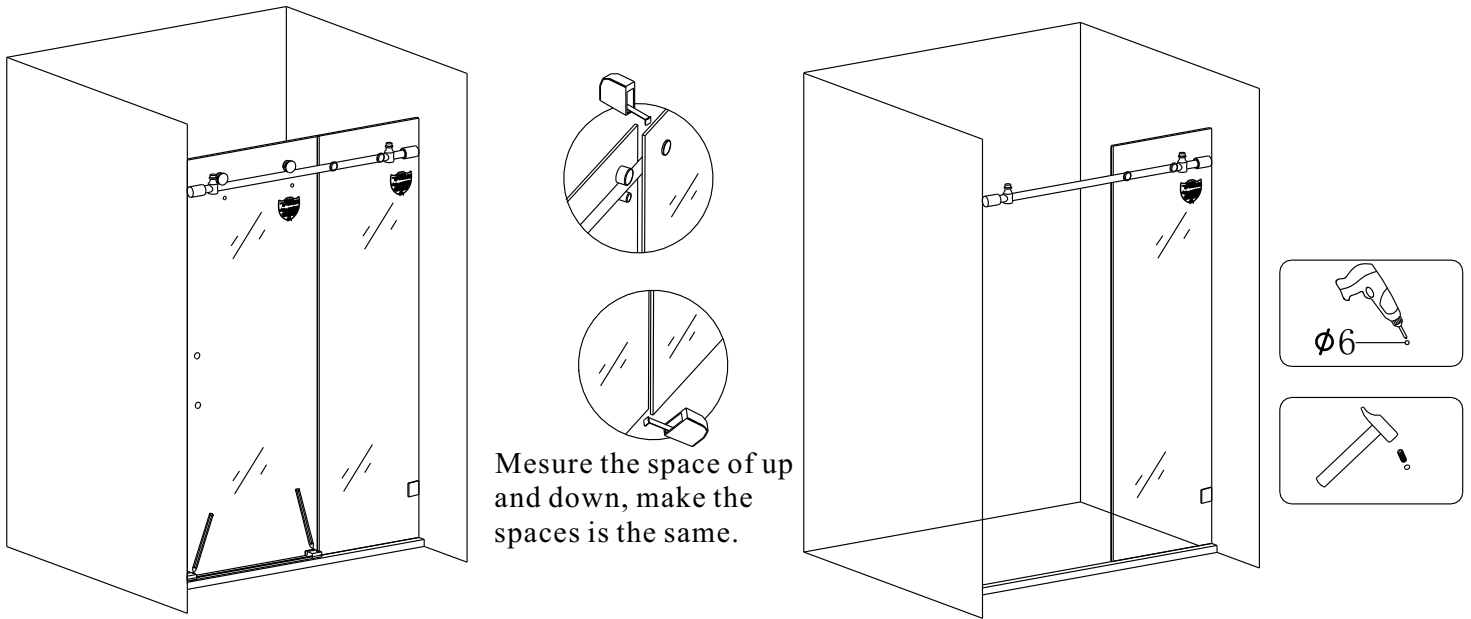

1. Put two plastic sliding cover and movable glass onto the base stone. Measure the space between the movable glass and fixing glass, make them vertically. Mark the sliding cover position by pencil, take off movable glass and sliding cover, then drill a hole by a  $\phi 6$  driller and insert with inflatable rubber.

6

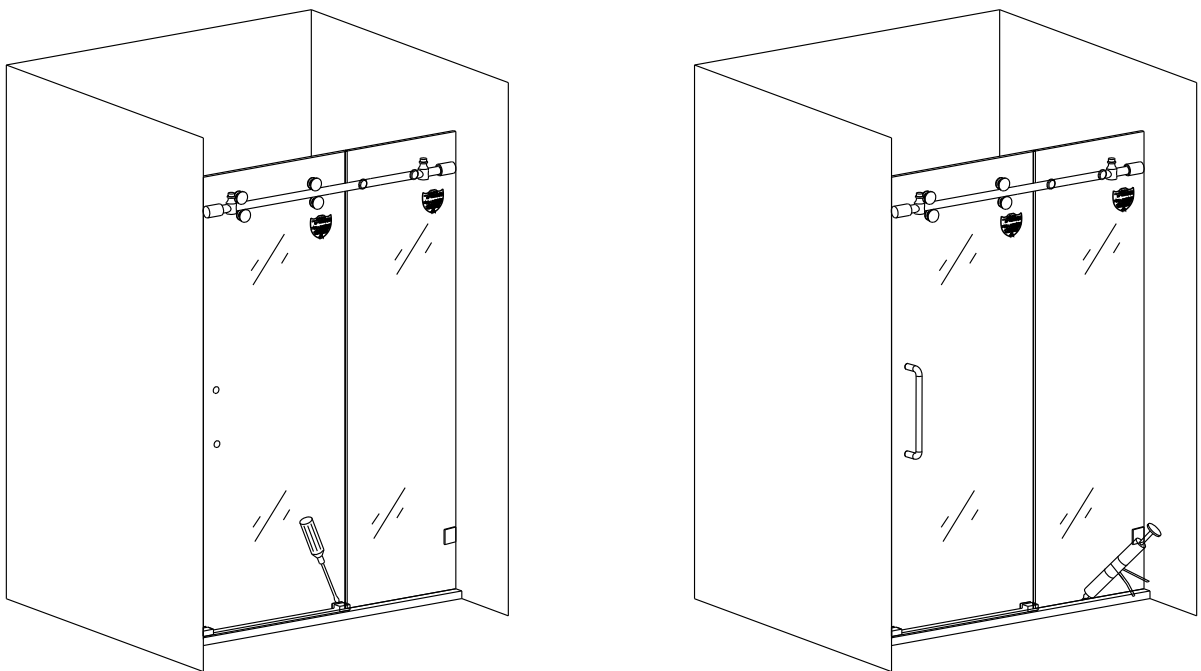

1. Put the waterproof bar on the base stone, locked it tight with tapping screw  $M4 \times 25$ .
2. Put the movable glass onto the upper rail, adjust the balance of wheel. Assemble with needle, bubble rubber and waterproof rubber.
3. Sealed with glass glue around the shower room. It can be used after 24 hours.