







# Installation for Instruction

ITEM NO:LY9201-11

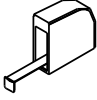
## Tools you need

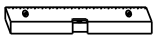
				
cross-screwdriver	hammer	electric drill	tape measure	caulking gun
				
Utility knife	horizontal ruler	pencil		

## Installation diagram

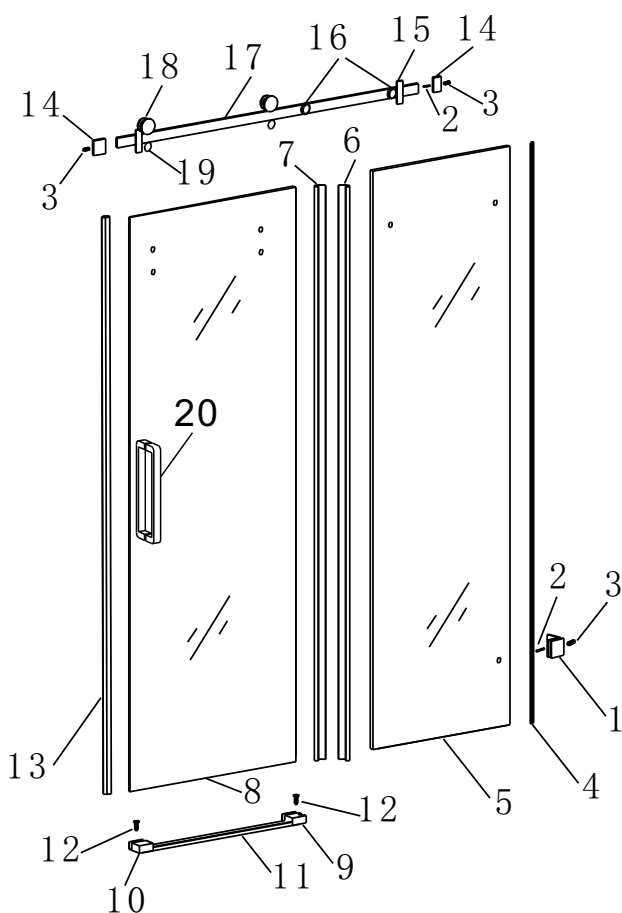

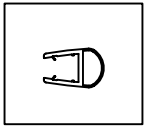
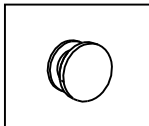
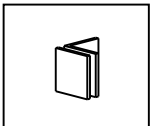
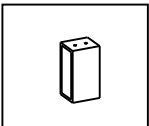
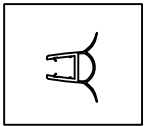
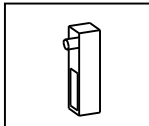
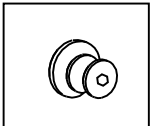
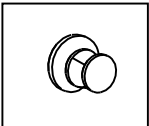
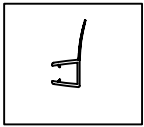
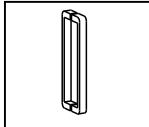
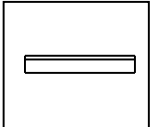
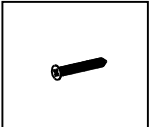
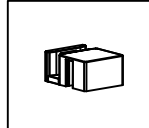
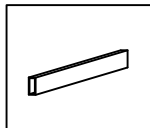
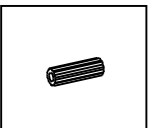
			
anti-collision rubber strip (1 pcs)	eccentric wheel (2 pcs)	fixing clamp (1 pcs)	tube (2 pcs)
			
anti-collision rubber strip (1 pcs)	locator (2 pcs)	pipe clamp (2 pcs)	needle (2 pcs)
			
Water bar (2 pcs)	s/s handle (1 pcs)	s/s square tube (1 pcs)	Screw (5 pcs)
			
sliding cover (2 pcs)	Waterproof bar (1 pcs)	Expansion glue (5 pcs)	

## Spare parts List

7	Water bar	14	tube		
6	Water bar	13	bubble rubber bar	20	s/s handle
5	fixing glass	12	Flat tapping screw M4×30	19	needle
4	bubble rubber	11	Waterproof bar	18	eccentric wheel
3	Inflatable glue 8mm	10	Right sliding cover	17	s/s square tube
2	Tapping screw M5×30	9	Left sliding cover	16	pipe clamp
1	fixing clamp 45×45mm	8	movable glass	15	locator
No.	Description	No.	Description	No.	Description

①

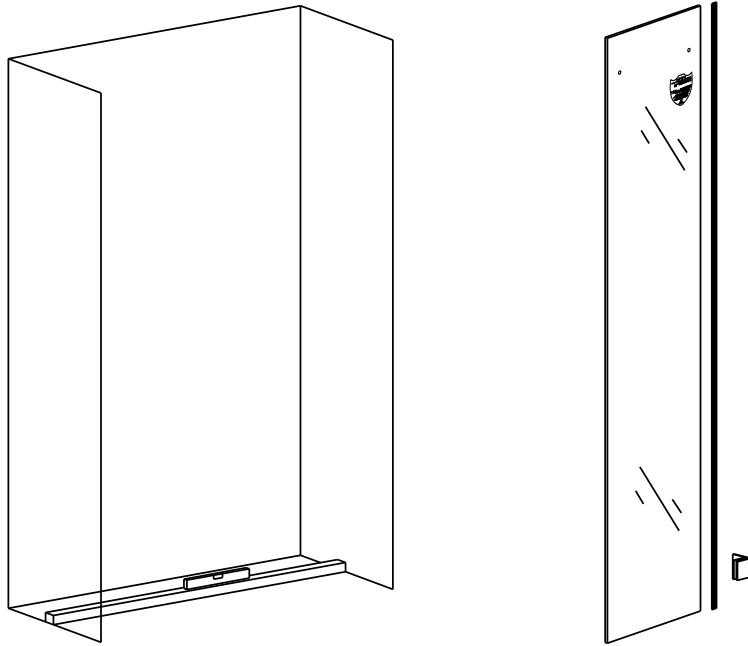

1. Select the installation position, put the base stone or tray to the position and measure it vertically by spirit level.
2. Assemble the accessories and glass, bubble rubber bar and fixing clamp on the fixing glass.

②

Attention: The safety membrane is stucked at the inside of the glass.

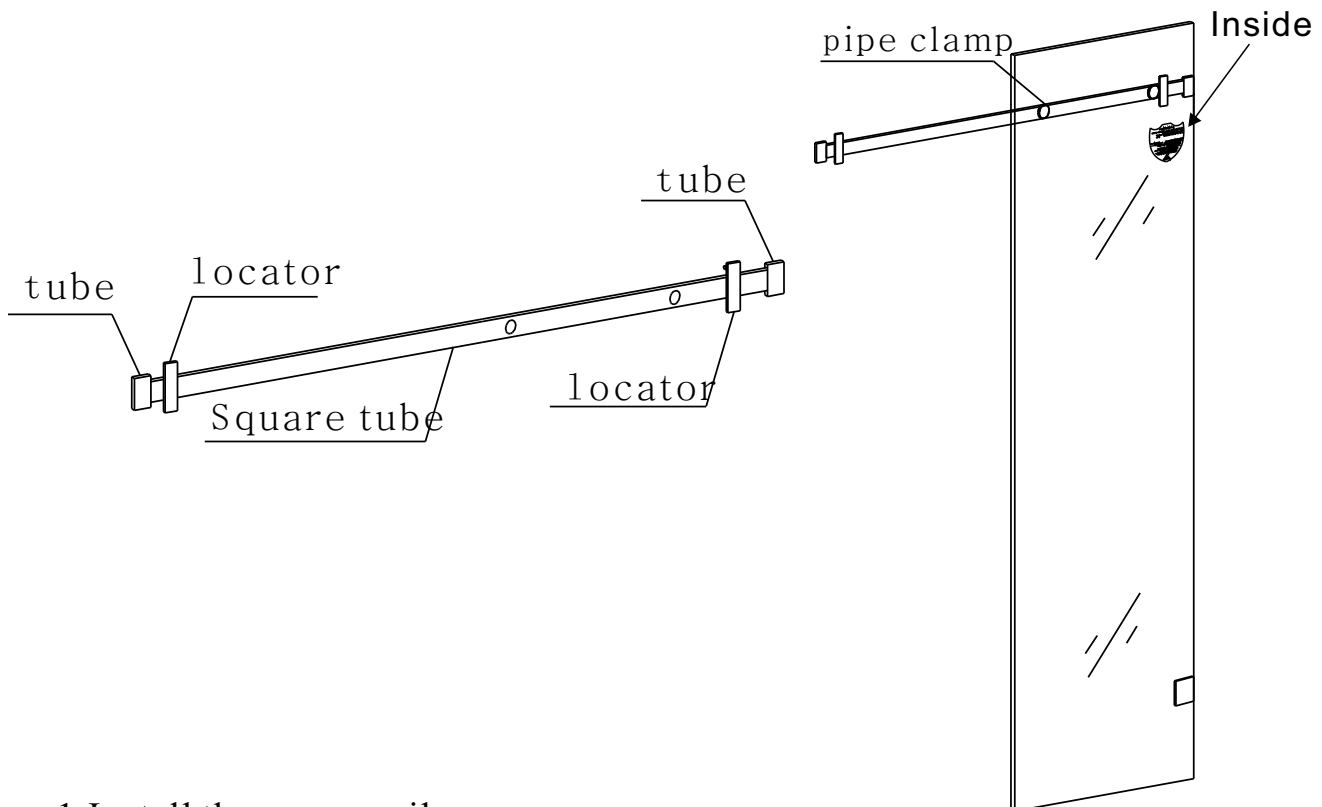

1. Install the rupper rail.
2. Put the movable glass onto the sliding wheel, and install the upper rail.

③

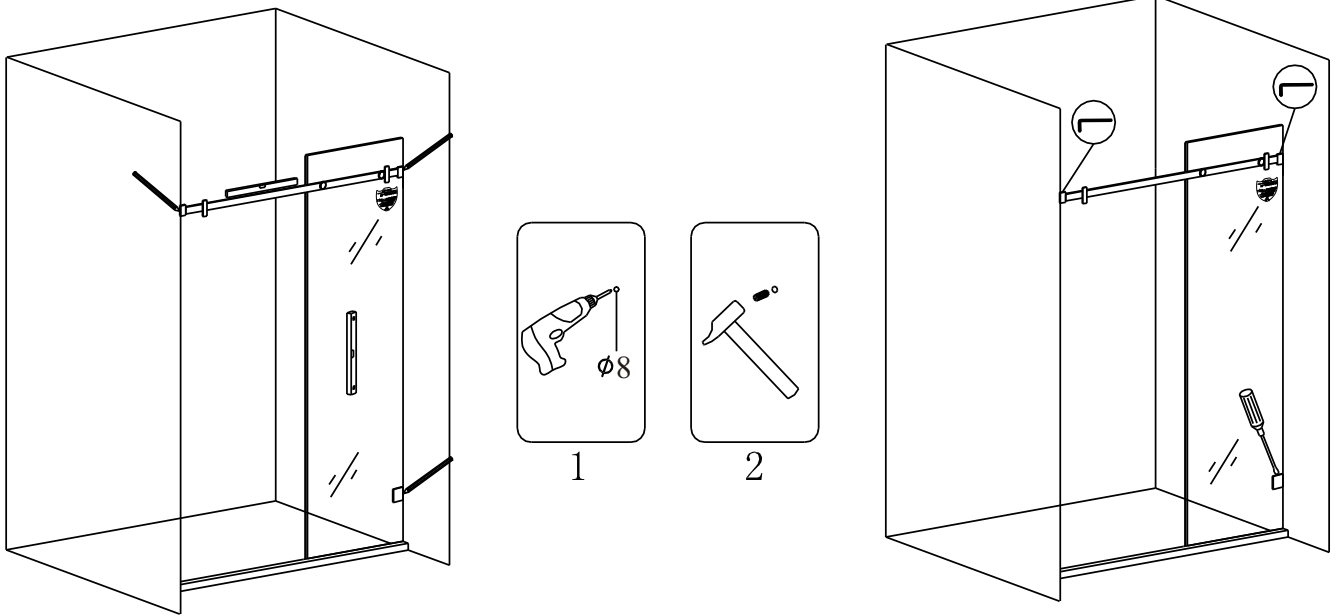

1. Put the fixing glass on the base stone, measure and make the upper rail and fixing glass vertically by spirit level, marked by pencil, then take off the fixing glass.
2. drill a hole by a  $\varnothing 8$  driller on the marked position, and insert with inflatable rubber.
3. Put the fixing glass which is with rupper rail on the base stone, make it vertically. Locked the fixing clamp tight with tapping screw  $M5 \times 30$ , and the tube is locked by flat tapping screw  $M5 \times 30$ .

④

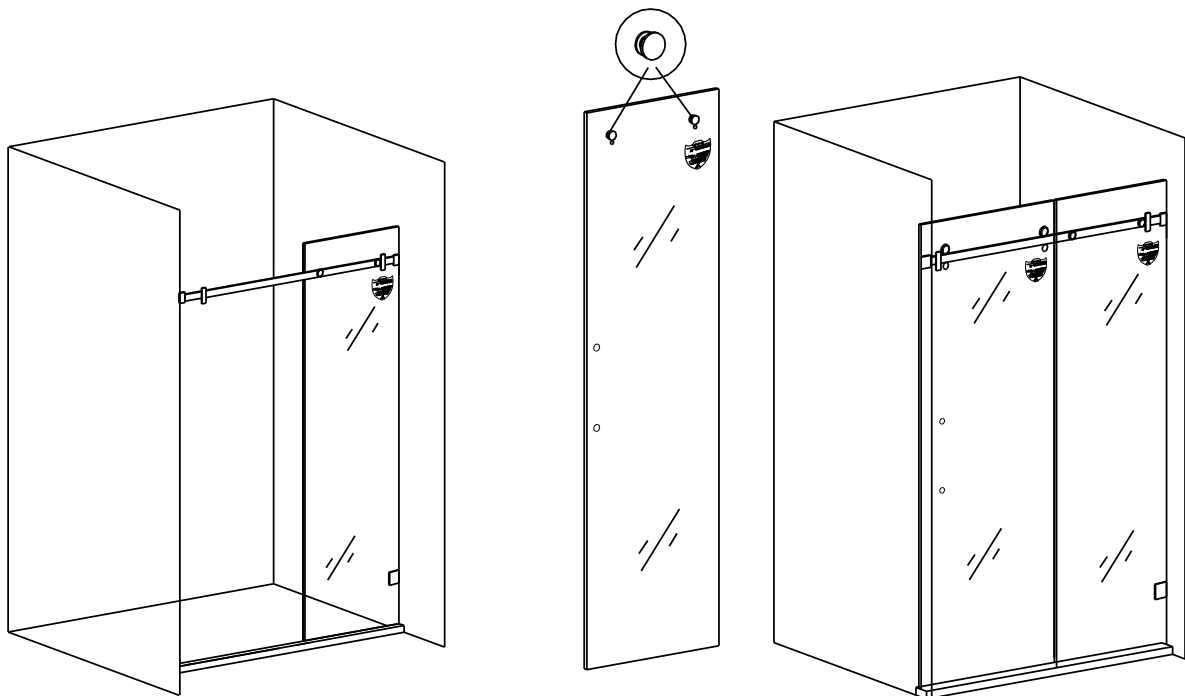

1. Put the fixing glass onto the waterproof bar.
2. Put the movable glass onto the sliding wheel, and install the upper rail.

5

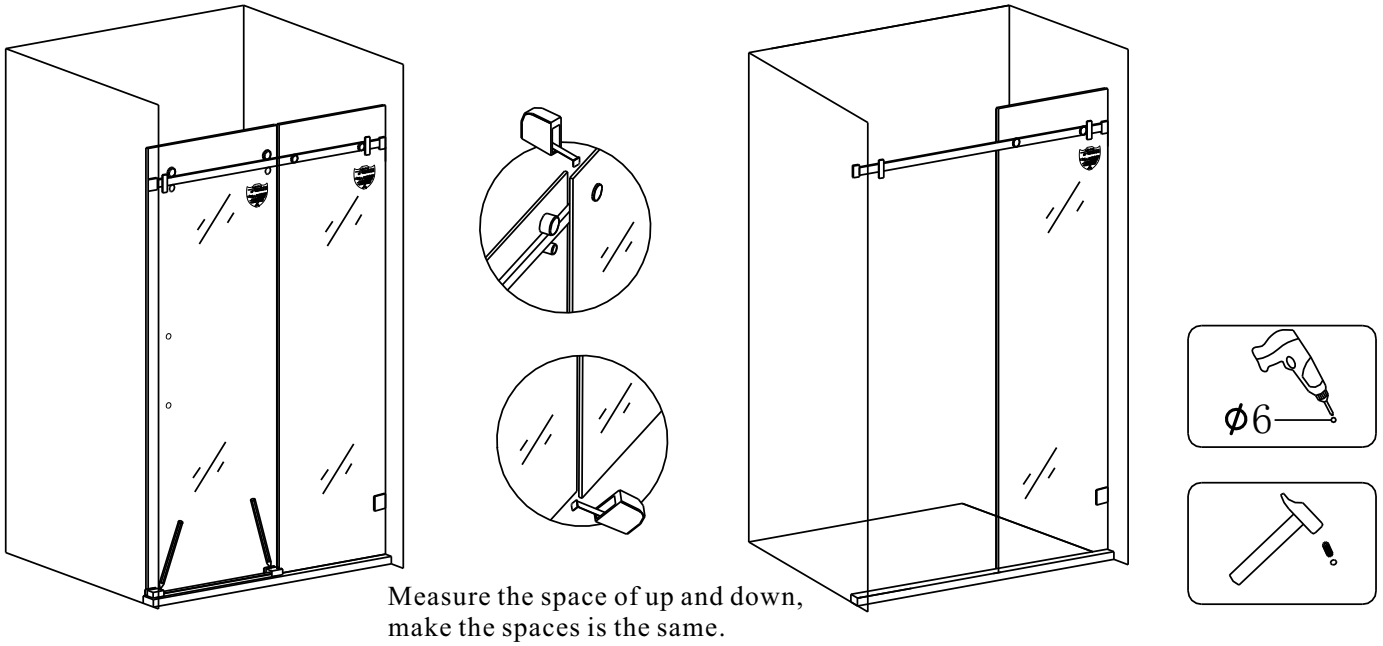

1. Put two plastic sliding cover and movable glass onto the base stone. Measure the space between the movable glass and fixing glass, make them vertically. Mark the sliding cover position by pencil, take off movable glass and sliding cover, then drill a hole by a  $\phi 6$  driller and insert with inflatable rubber.

6

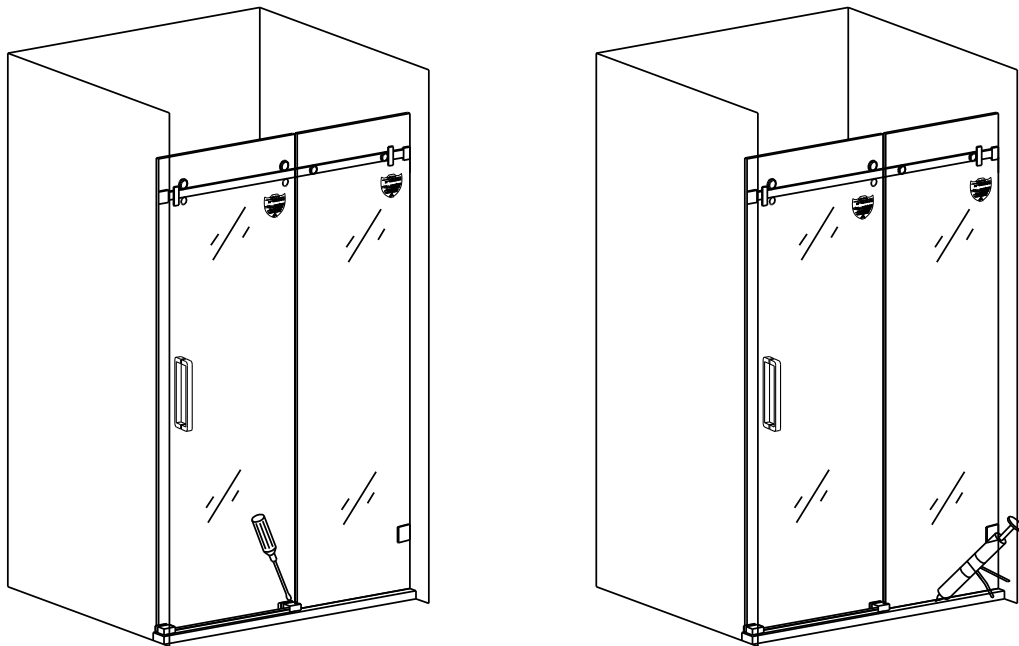

1. Put the waterproof bar on the base stone, locked it tight with tapping screw.
2. Put the movable glass onto the upper rail, adjust the balance of wheel.  
Assemble with needle, bubble rubber and waterproof rubber.
3. Sealed with glass glue around the shower room. It can be used in 24 hours.



**Please read this instructions before installation.**

### **Precautions before installation.**

- The shower room should be installed by professionals according to instructions. Otherwise, the shower room may be unstable or fall down which will lead to product broken or people injured.
- Count the object quantity. The glasses must be moved by two people. Put a soft and non-slip object under the glass and stand the glass against a wall smoothly. It will make the glass broken if it is placed in horizontal position. Pay attention to avoid hitting the four corners of the glass.
- Don't strongly knock the glass to avoid being broken.
- Before install the shower room, read the instructions carefully and know well about the tooling and installation sequence.
- It can be used and clean after 24 hour installation.

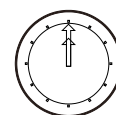
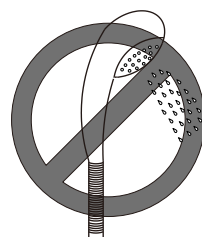

**24 H**

## Maintenance and repair

- 1、 Don't let children, older people or activity restricted people go into the shower room alone.
- 2、 Don't climb,lean against or hang something heavy on the shower room.
- 3、 Don't be rubbed or knocked by hard object, in case to cause broken.
- 4、 Don't make the burning cigarette near the shower room, and don't leave cigarette ash in the shower room. The burning flame will destroy the spray and glass, so it must keep away from fire.
- 5、 Before entering the shower room, pay attention the height of the falling in order to avoid getting tripped.
- 6、 Before entering the shower room, don't put the hand into the crack of the door,in case any injured occur.
- 7、 The soap suds in the shower room will make people slip very easily, Be careful not to slip.
- 8、 The shower room should be kept in good ventilation, in case to avoid leaving the moisture long stay in the shower room, and cause mildew and bad smell.
- 9、 Regularly clean the sliding rail, sliding wheel and sliding lump, add lubricant (lubricant oil or lubricant wax).
- 10、 Regularly adjust the screw of sliding wheel, sliding lump to make sure the effective load bearing and good sliding position of the moving door.
- 11、 Please use neutral liquid detergent and smooth fabric to clean the shower door. Don't use any acidity, alkaline detergent,thinner, alcohol, acetone and any stronge detergent.
- 12、 When dirty water appear on the water retaining stone, you can wipe it with a little toothpaste by wet fabric.
- 13、 It will be leaking if the glass seal is dropped. So please make it up when dropped.

